

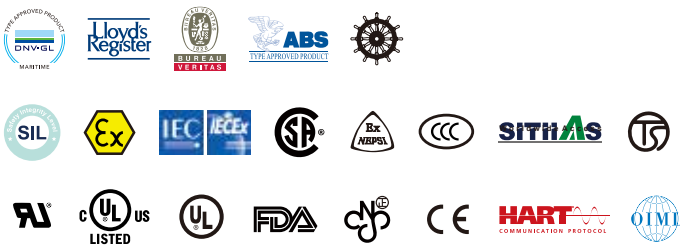

Magnetostrictive Level Transmitter



INTRODUCTION

The FineTek magnetostrictive level transmitter identifies the level of liquids and solutions with high precision and reliability.

This versatile sensor is ideal for continuous level measurement of a wide range of liquids. Application ranges from petrochemical industries, marine and shipping to food and beverage production.

The sensor has a loop power supply and provides direct analog or digital output to the user interface.

The FineTek magnetostrictive level sensor has proven itself due to its durability in a wide range of temperatures, pressures and operating conditions as well as its low maintenance nature.

FEATURES

- Absolute positioning output and no calibration required after power failure.
- Stability and reliability.
- Easy installation without calibration & maintenance.
- Prompt response time, high resolution & high accuracy.
- Durable structure, dust-proof, withstands high pressure.
- Oil/water dual level indication.
- The Max. operation temp. is 195BC.
- EG-6, 37, 60 adopted loop power structure for wire saving.
- Explosion-proof model available for hazardous environments.
- IP67(Enclosure)/IP69K(Probe).
- Support HART / RS485 and 4~20mA / voltage output.

APPLICATION

- Liquefied natural gas.
- Crude oil, petroleum's and diesels.
- Chemical processing.
- Pharmaceuticals and medication.
- Food and beverages, breweries.
- Dams, water barriers, wastewater treatment.
- Power plants, marine and shipbuilding.
- Tooling or alignment position for processing machines.

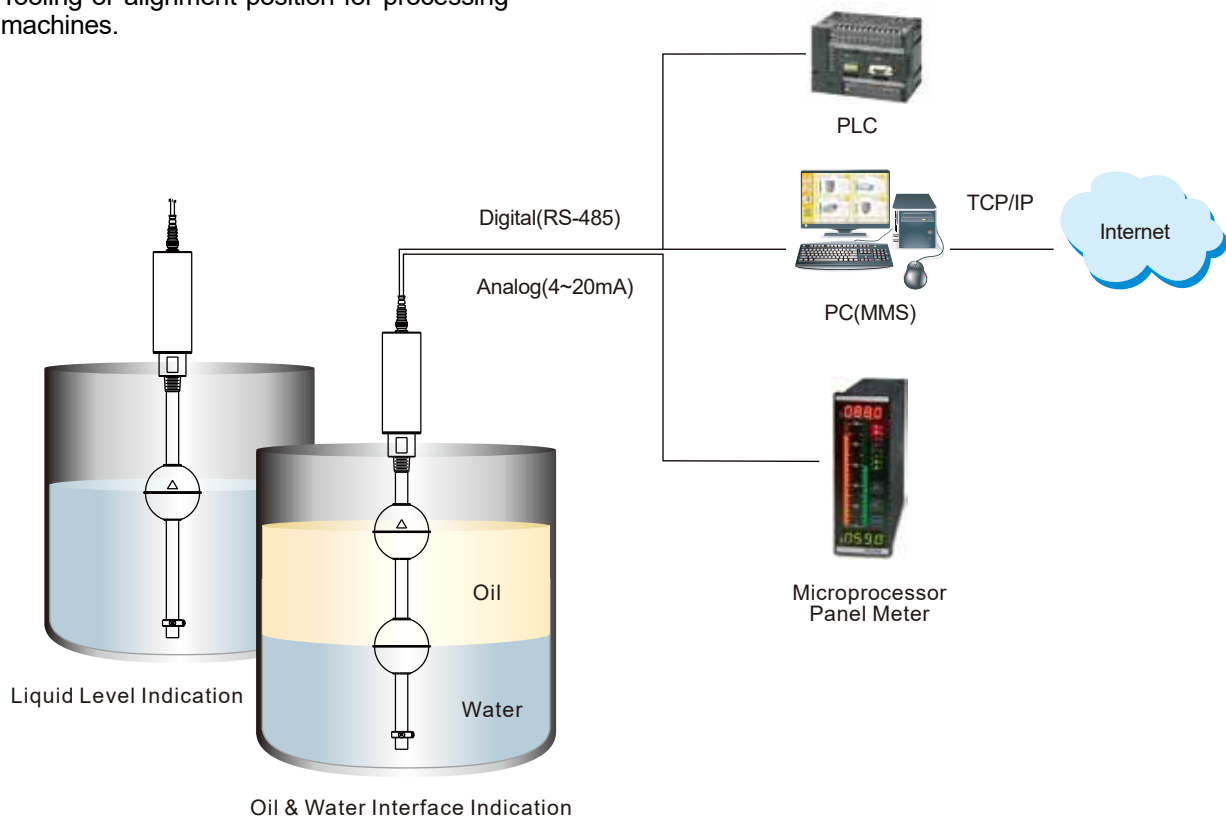

OPERATING PRINCIPLE

The sensor mainly consists of magnetorestrictive wires sealed in a stem/rod and a permanent magnet sealed into a float that can move up and down the stem. Electrical current travels along the wires in the stem creating an axial magnetic field. When the float's and stem's magnetic field intersect, a torsional force is created with different height levels (see right).

The sensor measures the liquid level (D) by calculating the elapsed time between torsional forces. Using velocity and time, distance can be calculated. This action is timely and continuous. A change in float position will be detected promptly via signal output.

CONVERSION FORMULA

The relation of ΔD & 4~20mA output

$$\frac{IX-4}{(20-4)mA} = \frac{\Delta T-TX}{\Delta T} = \frac{DX}{\Delta D}$$

$$\Rightarrow IX = \frac{16DX}{\Delta D} + 4mA \text{ (The relative current)}$$

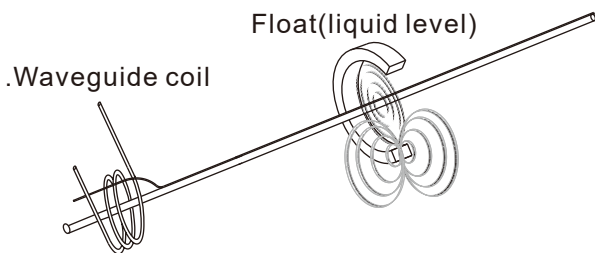
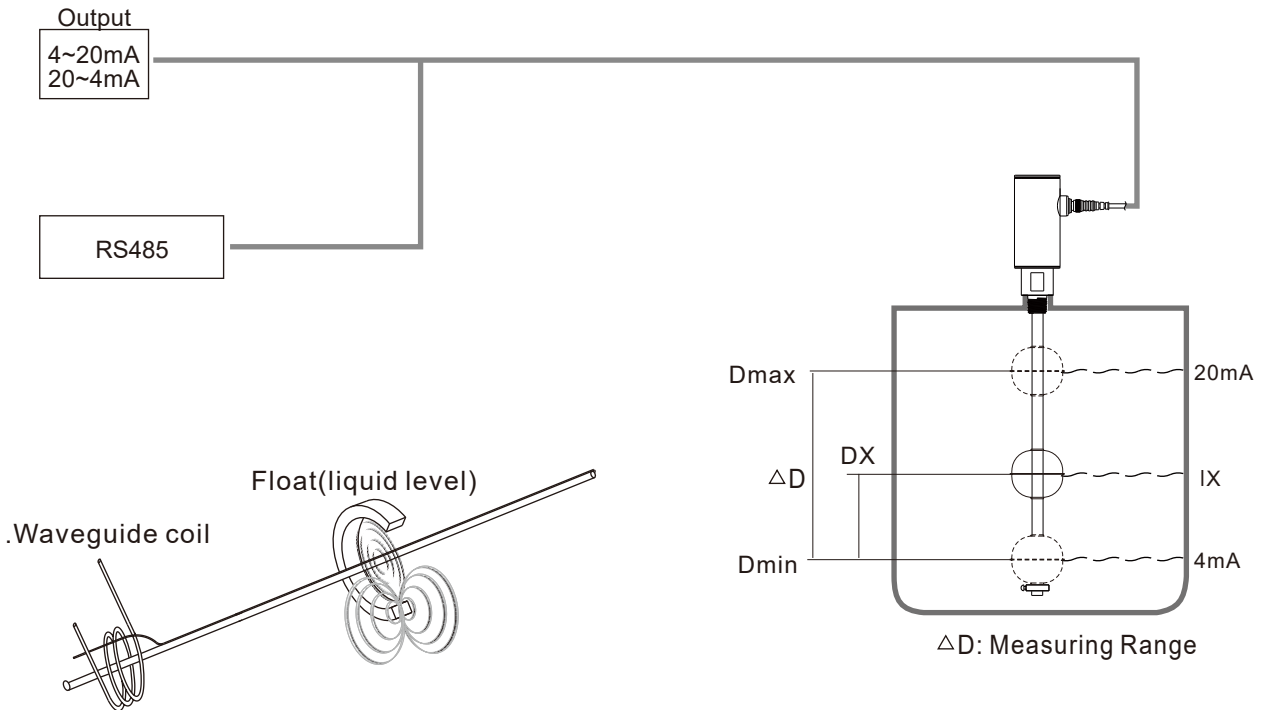
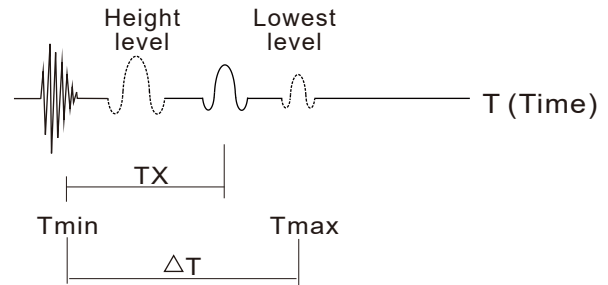

EXPLOSION PROOF MODEL

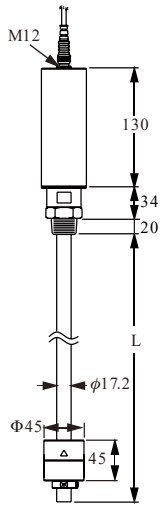
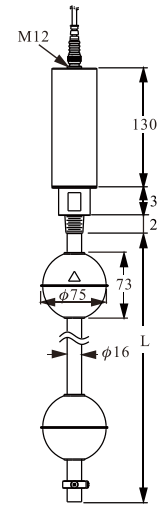

Dimensions (Unit: mm)	 <p style="text-align: center;">NEPSI Ex ia IIB T3-T6 Ga ATEX © II 1G Ex ia IIB T3-T6</p>	 <p style="text-align: center;">NEPSI Ex ia IIB T3-T6 Ga ATEX © II 1G Ex ia IIB T3-T6</p>
Model No.	EG374 (Anti-Corrosion Model)	EG371 (Single/dual Float Model)
Application	For acid/alkali corrosion liquids.	For single/dual level and interface measurement.
Measuring range	50~2000mm	50~5500mm
Non-Linearity	± 0.05% F.S. or ± 1.0mm (whichever is greater)	± 0.05% F.S. or ± 1.0mm (whichever is greater)
Repeatability	± 0.004% F.S.	± 0.004% F.S.
Temp. coefficient	± 100 ppm/°C	± 100 ppm/°C
Operation pressure	5 bar(Max.)	30 bar(Max.)
Ambient temp.	-40°C ~ 85°C	-40°C ~ 85°C
Operation temp.	-20°C ~ 80°C	-40°C ~ 125°C
Temp. accuracy	± 1°C	± 1°C
Output	4~20mA	4~20mA
Max load (Ω)	(VS-18)÷0.02 VS=Supply voltage	(VS-18)÷0.02 VS=Supply voltage
Digital output	RS485 / HART 7.3(option)	RS485 / HART 7.3(option)
Response time	16Hz	16Hz
Power supply	12~30V(4-wire), 18~30V(2-wire), 18~28V(Explosion proof)	12~30V(4-wire) ,18~30V(2-wire), 18~28V(Explosion proof)
Housing material	SUS304 (SUS316 option)	SUS304 (SUS316 option)
Connection	3/4"PT	1/2"PT
Wetted material	PP	SUS304
Enclosure	IP67 (Enclosure) / IP69K(Probe)	IP67 (Enclosure) / IP69K(Probe)

※ Must equipped with intrinsic safety barrier to form a standard intrinsically safe system (Ex ia), please refer to another catalog / brochure for TXX safety barrier.

※ The “4 Wire” type for EG36/ EG37 series: 2 wires are for power supply, the other 2 wires are for RS485 output. Please refer to wiring instruction in contents.

EXPLOSION PROOF MODEL

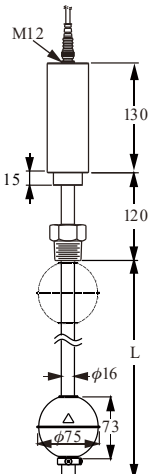
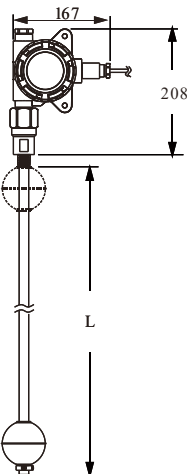

Dimensions (Unit: mm)	 <p style="text-align: center;">NEPSI Ex ia IIB T3-T6 Ga ATEX II 1G Ex ia IIB T3-T6</p>	 <p style="text-align: center;">NEPSI Ex ia IIB T3...T6 Ga ATEX II 1G Ex ia IIB T3-T6</p>
Model No.	EG37A (Ex-proof High Temp. Model)	EG36 (Diaplay Model)
Application	Explosion-proof model for hazadous environment.	Explosion-proof model with diaplay for hazadous environment.
Measuring range	50~5500mm	50~5500mm
Non-Linearity	±0.05% F.S. or ±1.0mm (whichever is greater)	50mm~4000mm ± 1mm 4000mm~5500mm ± 0.025% F.S.
Repeatability	± 0.004% F.S.	± 0.004% F.S.
Temp. coefficient	± 150 ppm/°C	± 100 ppm/°C
Operation pressure	30 bar(Max.)	30 bar(Max.)
Ambient temp.	-40°C ~ 85°C	-40°C ~ 85°C
Operation temp.	-40°C ~ 195°C	-40°C ~ 125°C
Temp. accuracy	± 1°C	± 1°C
Output	4~20mA	4~20mA
Max load (Ω)	(VS-18)÷0.02 VS=Supply voltage	(VS-16)÷0.02 VS=Supply voltage
Digital output	RS485 /HART 7.3(option)	RS485 /HART 7.3(option)
Response time	16Hz	16Hz
Power supply	12~30V(4-wire),18~30V(2-wire), 18~28V(Explosion proof)	12~30V(4-wire) ,16~30V(2-wire), 16~28V(Explosion proof)
Housing material	SUS304 (SUS316 option)	Aluminum
Connection	1/2"PT	1/2"PT
Wetted material	SUS304	SUS304
Enclosure	IP67 (Enclosure) / IP69K(Probe)	IP67 (Enclosure) / IP69K(Probe)

※ Must equipped with intrinsic safety barrier to form a standard intrinsically safe system (Ex ia), please refer to another catalog / brochure for TXX safety barrier.

※ The "4 Wire" type for EG36/ EG37 series: 2 wires are for power supply, the other 2 wires are for RS485 output. Please refer to wiring instruction in contents.

EG50 (4 Wire)

<p>Dimensions (Unit: mm)</p>	
Model No.	EG50
Application	Four wire output
Measuring range	50~1000mm
Linearity	Range of more than 500mm, error $\pm 0.1\%$ F.S Range of 500mm below the error of $\pm 500\mu\text{m}$
Repeatability	$\pm 0.005\%$ F.S.
Temp. coefficient	± 100 ppm/ $^{\circ}\text{C}$
Operation pressure	30 bar(Max.)
Ambient temp.	$-40^{\circ}\text{C} \sim 85^{\circ}\text{C}$
Operation temp.	$-40^{\circ}\text{C} \sim 125^{\circ}\text{C}$
Temp. accuracy	$\pm 0.5^{\circ}\text{C}$
Output	4~20mA / 20~4mA
Max load (Ω)	$(\text{VS}-18) \div 0.02$ VS=Supply voltage
Digital output	RS485 (Option)
Response time	1KHz
Power supply	18~30V
Housing material	SUS304 (SUS316 Option)
Connection	M18x1.5
Wetted material	SUS304(SUS316 Option)
Enclosure	IP67 (Enclosure) / IP69K (Probe)

※ The output with 2 sets of 4~20mA analog output is available for EG50 series.

EG60 (2 Wire / 4 Wire)

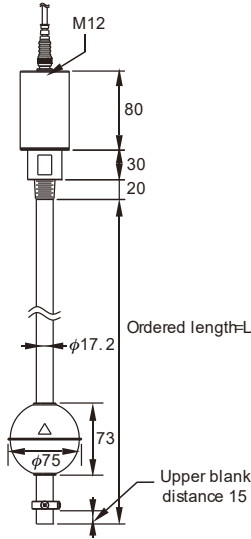
Dimensions (Unit: mm)		
Model No.	EG60 Two wire	EG60 Four wire
Application	Two wire loop Power output, comply with HART demand.	Four wire output
Measuring range	50~5500mm	50~2500mm
Linearity	(50~2000mm), 1mm (2001~5500mm), 0.05%F.S	(50~500mm), 0.1mm (50~500mm), 0.2mm (50~500mm), 0.5mm (500~2500mm), 0.02%F.S (500~2500mm), 0.05%F.S (500~2500mm), 0.1%F.S
Repeatability	± 0.002% F.S.	
Temp. coefficient	± 100 ppm/°C	
Operation pressure	30 bar(Max.)	
Ambient temp.	-40°C~ 85°C	
Operation temp.	-40°C ~ 125°C (Std. model) , -40~195BC (High temp. model)	
Temp. accuracy	K0.5°C	
Output	4~20mA/ 20~4mA	0~10V, 10~0V, 0~5V, 5~0V, 4~20mA, 20~4mA
Max load (Ω)	$(VS-18) \div 0.02$ VS=Supply voltage	500W
Digital output	RS485 , HART (Option)	RS485 (Option)
Response time	16Hz	250Hz
Power supply	18~30V	
Housing material	SUS304 (SUS316 Option)	
Connection	1/2"PT	
Wetted material	SUS304	
Enclosure	IP67 (Enclosure) / IP69K (Probe)	

HOUSING OPTIONS

Mapping table of enclosure

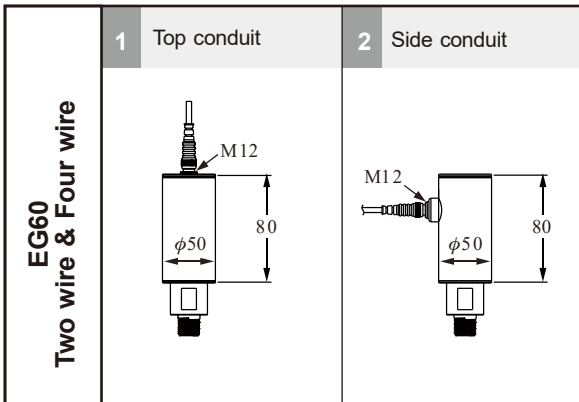
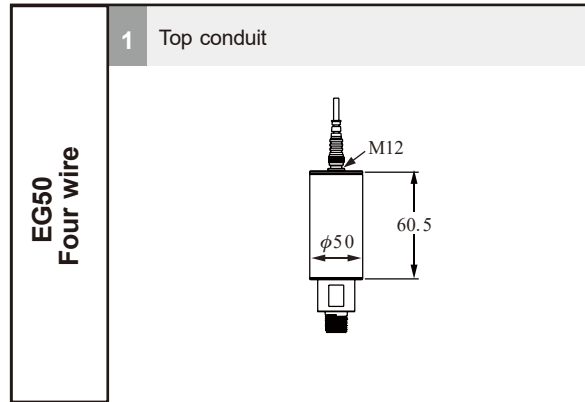
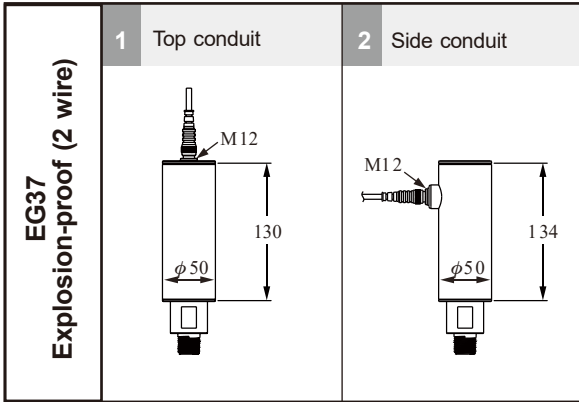

※ Standard model cable length is 2m.

External structure-Double float

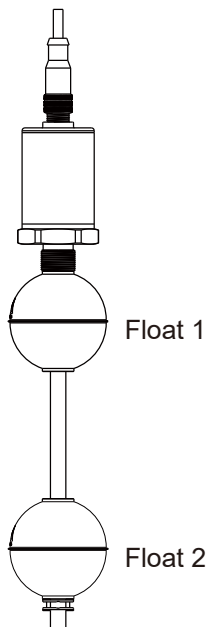

FLOAT SPECIFICATIONS

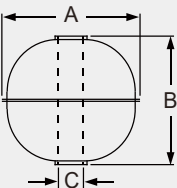
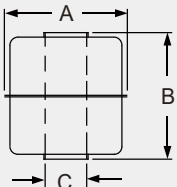
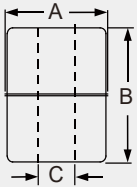
Model	Model Number	Dimensions ($\phi A \times B \times \phi C$ mm)	S.G.	Max. Pressure (kg/cm ²)	Material	Stem Size
	S5	75x73x20.5	E>0.7	30	SUS 304 / 316	$\phi 16$
	S4	52x52x15	E>0.75	30	SUS 316	$\phi 12.7$
	SD	52x52x15	E>0.9	30	SUS 316	$\phi 12.7$
	SE	75x73x20.5	E>0.9	20	SUS 304 / 316	$\phi 16$
	A1	32x69x10.9	E>0.75	10	SUS 316 / 316L	$\phi 8$
	AA	32x69x10.9	E>0.9	10	SUS 316 / 316L	$\phi 8$
	S3	45x55x15	E>0.7	12	SUS 316	$\phi 12.7$
	SC	45x55x15	E>0.9	12	SUS 316	$\phi 12.7$
	F3	45x45x20	E>0.65	5	PP in Grey	$\phi 18$ (coating)
	FC	45x45x20	E>0.9	5	PP in Grey	$\phi 18$ (coating)
	P3	48x45x18.5	E>0.6	5	PP in Black	$\phi 17.2$ (coating)
	PC	48x45x18.5	E>0.9	5	PP in Black	$\phi 17.2$ (coating)
	NB	48x46x15.6	E>0.5	30	NBR in Black	$\phi 12.7$
	ND	48x46x15.6	E>0.9	30	NBR in Black	$\phi 12.7$
	NE	48x46x20	E>0.9	30	NBR in Black	$\phi 16$

※ S.G(E):specific gravity

※ Probe diameter must be smaller then float's hole diameter.

WIRING

When RS485(ModBus)is applied,Loop power only as power.

EG37 / EG60 (2 wire):

1. Single / Double float +RS485

Loop Power 24Vdc ± 10%

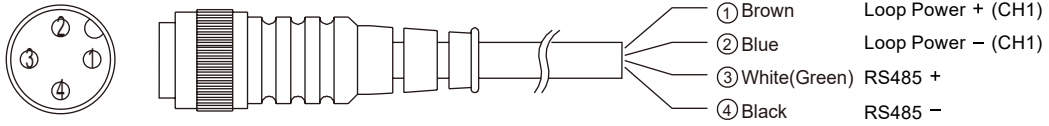

2. Single / Double float +HART

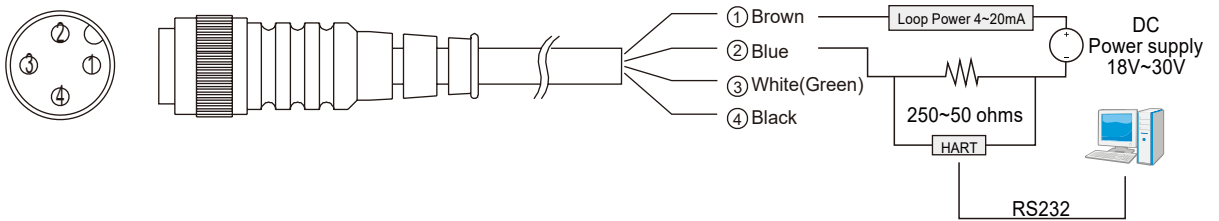

EG36:

Single / Double float +RS485

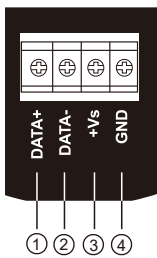

- ① D +: RS485 +
- ② D -: RS485 -
- ③ V +: Loop Power +
- ④ V -: Loop Power -

CUSTOMIZED STEM LENGTHS ARE AVAILABLE

Note the difference between ordered length and actual measurable stem length below.

(2m below)= Actual measurable length (X) =Ordered length (L)-52mm-15mm,adopted stem f12.7

(2m above)= Actual measurable length (X) =Ordered length (L)-73mm-15mm,adopted stem f16

(2μ below)= Actual measurable length (X) =Ordered length (L)-45mm-25mm,adopted stem f17.2

Below 2m,stem $\phi 12.7$

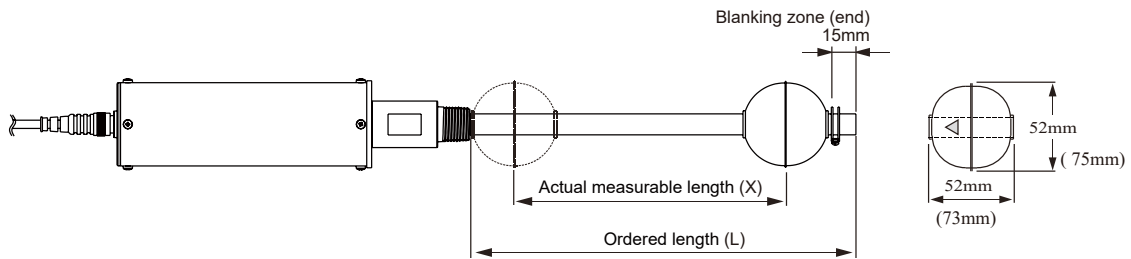

Above 2m,stem $\phi 16$

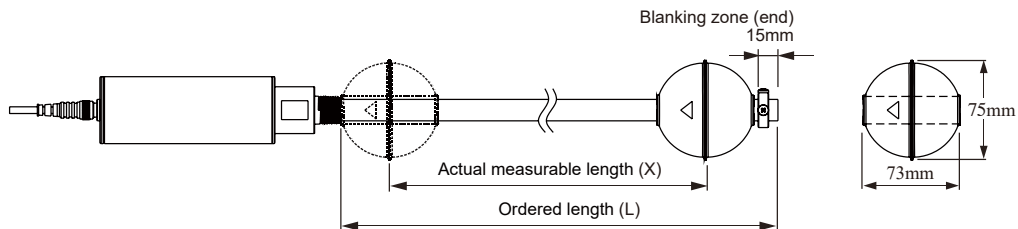

Below 2m,stem $\phi 12.7$,with PP coating to $\phi 17.2$

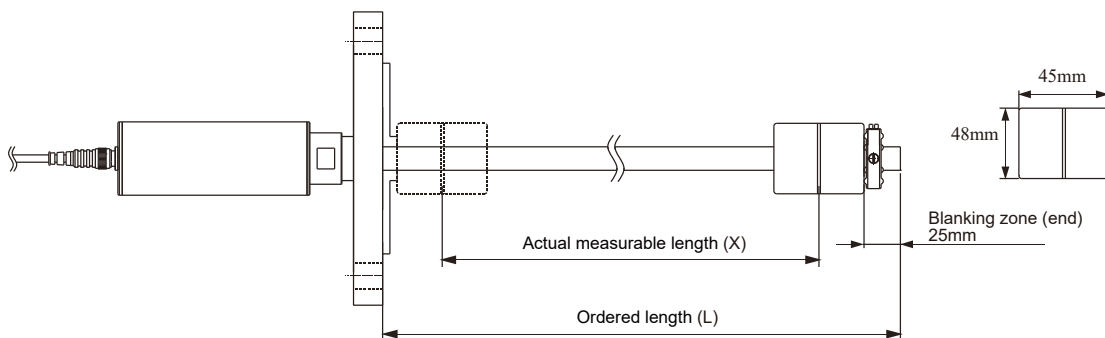

INSTALLATION

1. Loop power 24Vdc \pm 10%
2. The product is calibrated before shipment and should be sufficient to meet user needs.
3. Do not bend the stem, put pressure on it or force it in any manner.
4. For best results, use the included float only.
5. When the mounting hole is large enough, guide the stem and float through the hole to install.
6. If the hole is NOT large enough, remove float, install the stem and assemble float from inside the container.
7. When assembling the float onto the stem, the float's direction mark should face the housing.
8. Ensure the float stopper is fixed firmly.
9. If the stem is bent and can not work, it needs to be returned to the factory for calibration.
11. Bubble wrap/foam packaging is necessary to ensure safety during transportation.
12. Unnecessary opening of housing may affect accuracy.

Removing the float

Step 1:
Loosen the stopper at stem end

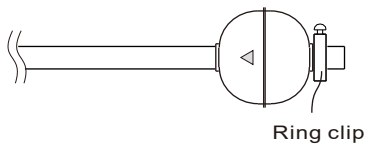

Step 2:
Take off the float

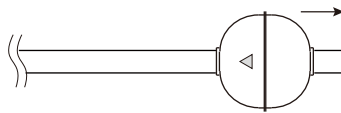

Step 3:
Install the sensor onto the tank,
and tighten the connection

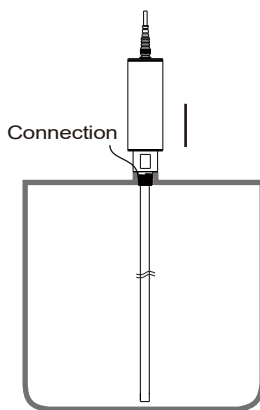

Step 4:
Assemble the float onto the stem
and tighten the connection the
housing. Note the direction of float

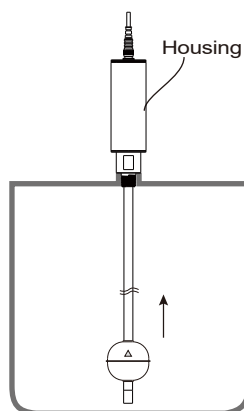

Step 5:
Firmly fasten the stopper

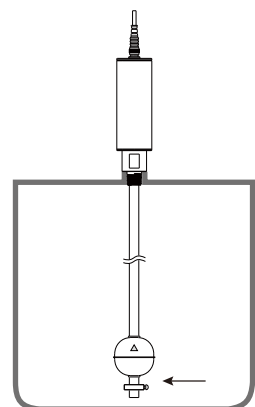

MODEL NUMBER / ORDER CODE COMPARISON TABLE

Model Number	Order Code
EG374 Anti-Corrosion type	EGX1001B-B1
EG371 Ex- Proof type	EGX1001B-A1
EG37A Ex- Proof High temperature type	EGX1021B-A1
EG36 Display type	EGX3001B-A1
EG36 High temperature display type	EGX3021B-A1
EG50	EGX5 9999-99
EG60	EGX6 9999-99

ACCESSORIES

Cable Conduit - Ex d IIC

Material: Washer — NBR

Body— Copper alloy(3/4"NPT)

Nickel plated(1/2"NPT)

HP415-A23100MH01(29-1104)

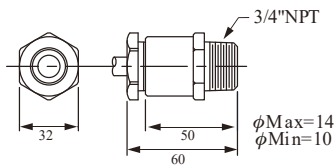

HP415-A23000MG01(29-1108)

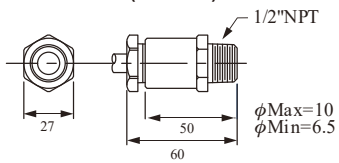

Global Network

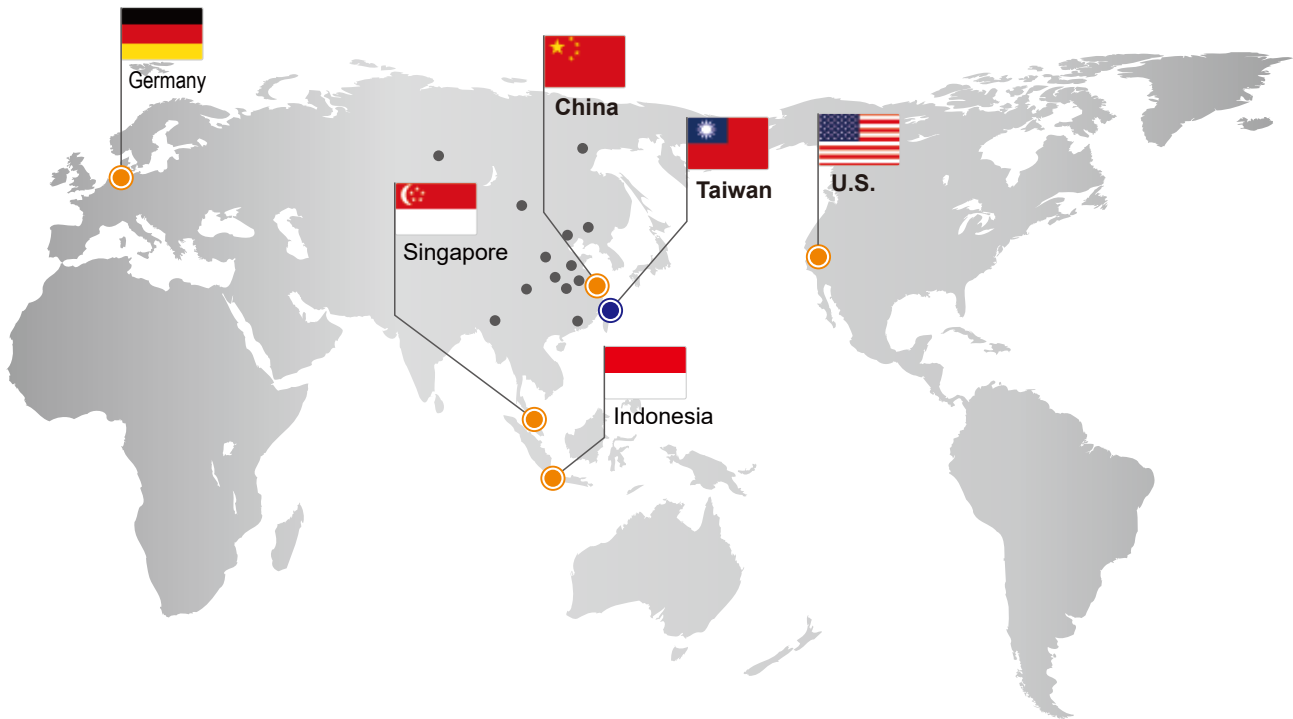

■ Head Quarter

- Taiwan
FineTek Co., Ltd. - Taipei Head Quarter 
No.16, Tzuchiang St., Tucheng Industrial Park
New Taipei City 236, Taiwan
TEL: 886-2-2269-6789
FAX: 886-2-2268-6682
EMAIL: info@fine-tek.com



■ North America

- California, U.S.
Aplus Finetek Sensor Inc. - US Office
355 S. Lemon Ave, Suite D
Walnut, CA 91789
TEL: 1 909 598 2488
FAX: 1 909 598 3188
EMAIL: info@aplusfine.com

■ Europe

- Germany
FineTek GmbH - Germany Office
Bei den Kämpen 26
21220 Seevetal-Ramelsloh, Germany
TEL: +49-(0)4185-8083-12
FAX: +49-(0)4185-8083-80
EMAIL: info@fine-tek.de

■ Asia

- China
Fine automation Co., Ltd. - Shanghai Factory 
No.451 DuHui Rd, MinHang District, Shanghai,
China 201109
TEL: 86-21-6490-7260
EMAIL: info.sh@fine-tek.com
- Singapore
FineTek Pte Ltd. - Singapore Office
37 Kaki Bukit Place, Level 4 Singapore 416215
TEL: 65-6452-6340
EMAIL: info.sg@fine-tek.com
- Indonesia
PT. FineTek Automation Indonesia - Indonesia Office 
PERGUDANGAN TUNAS BITUNG
JL. Raya Serang KM. 13,8, Blok C3 No. 12&15, Bitung Cikupa,
Tangerang 15710
TEL: 62 (021)-2958-1688
EMAIL: info.id@fine-tek.com

- Müttec Instruments GmbH - Germany Office 
Bei den Kämpen 26
21220 Seevetal-Ramelsloh, Germany
TEL: +49-(0)4185-8083-0
FAX: +49-(0)4185-8083-80
EMAIL: muetec@muetec.de



Distributor: